

Przekrój poziomy A | horizontal section A

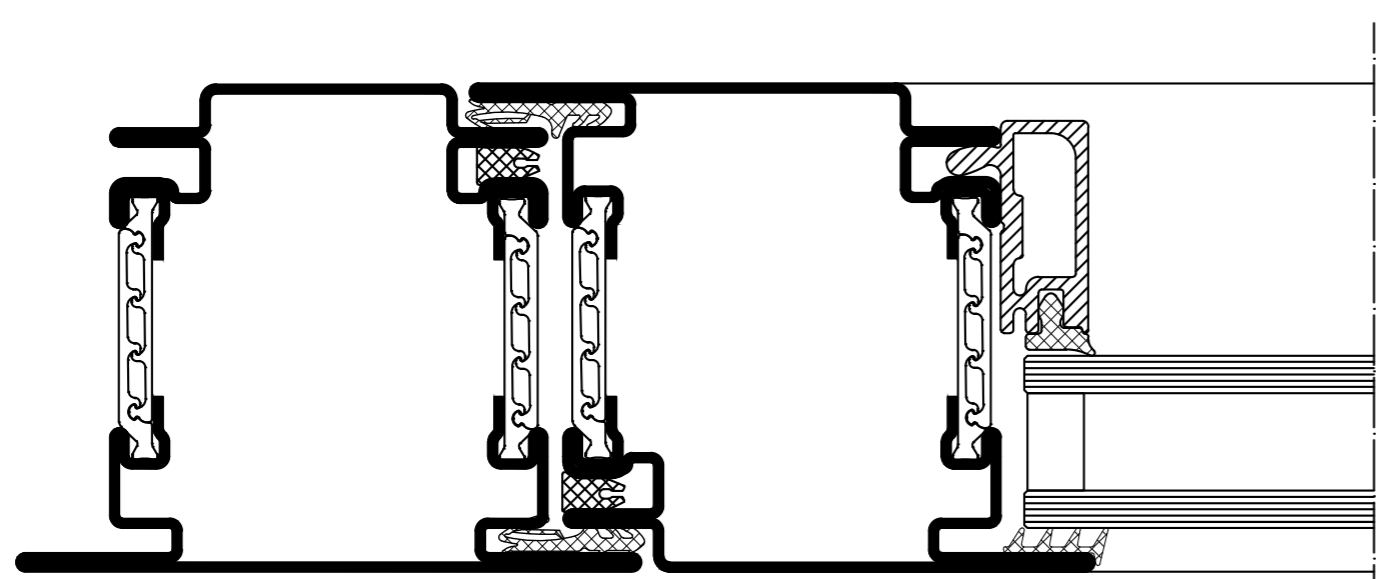

Przekrój pionowy B | vertical section B

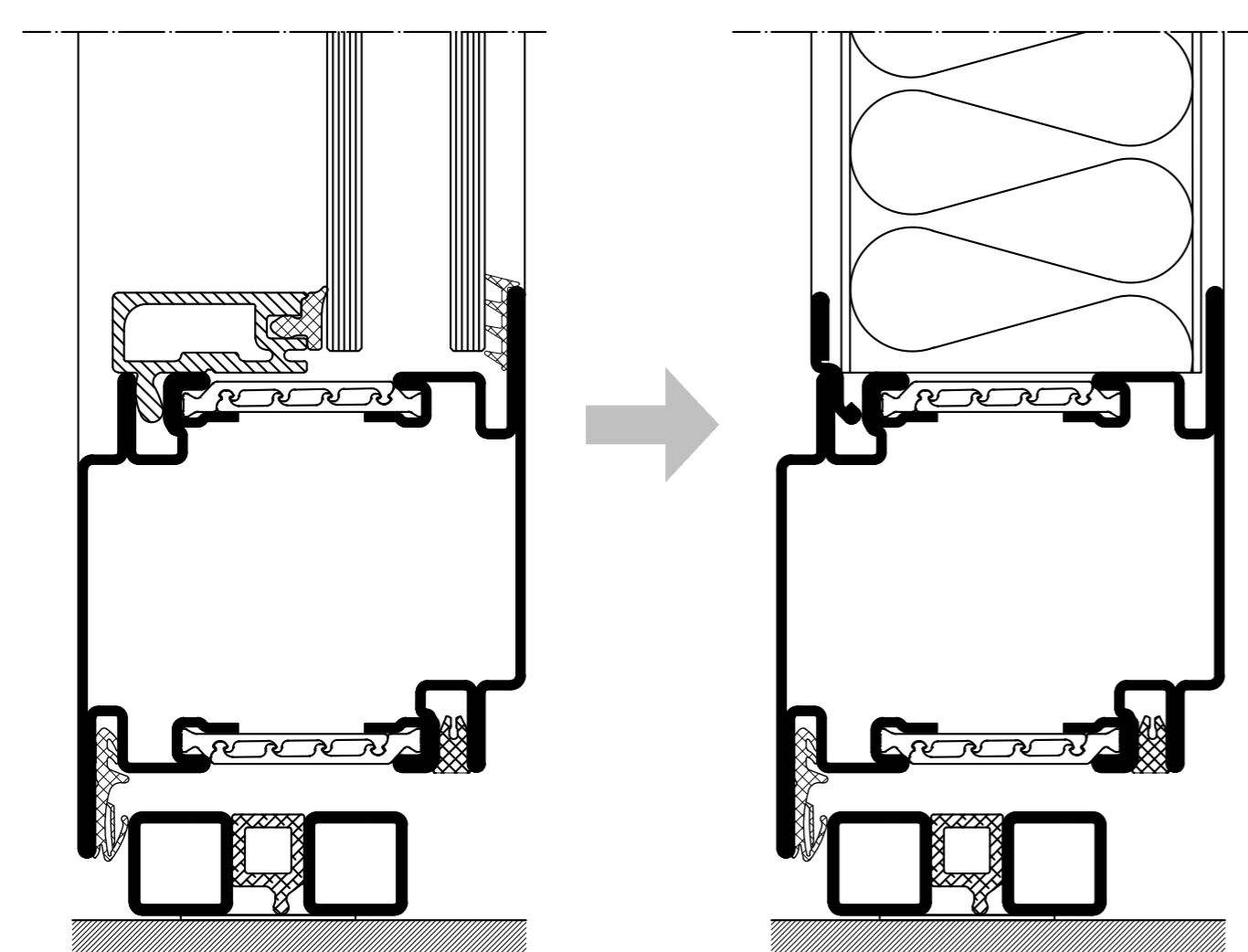

Przykładowe rozwiązanie

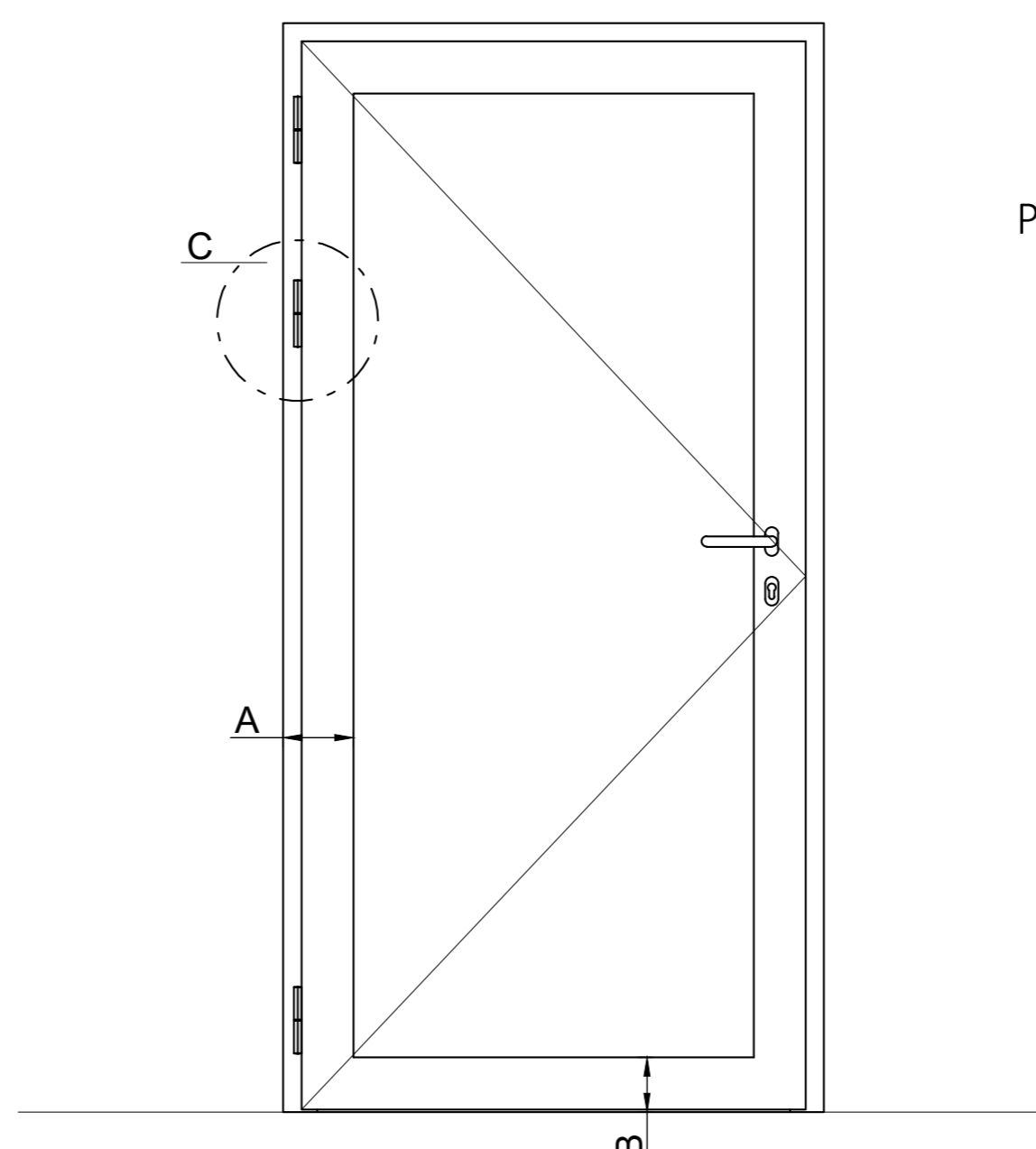

Przekrój C | horizontal section C

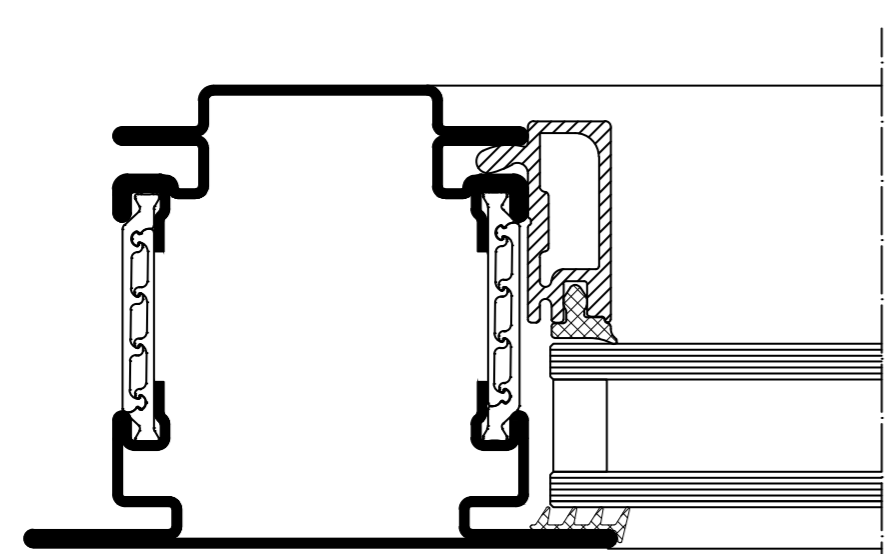
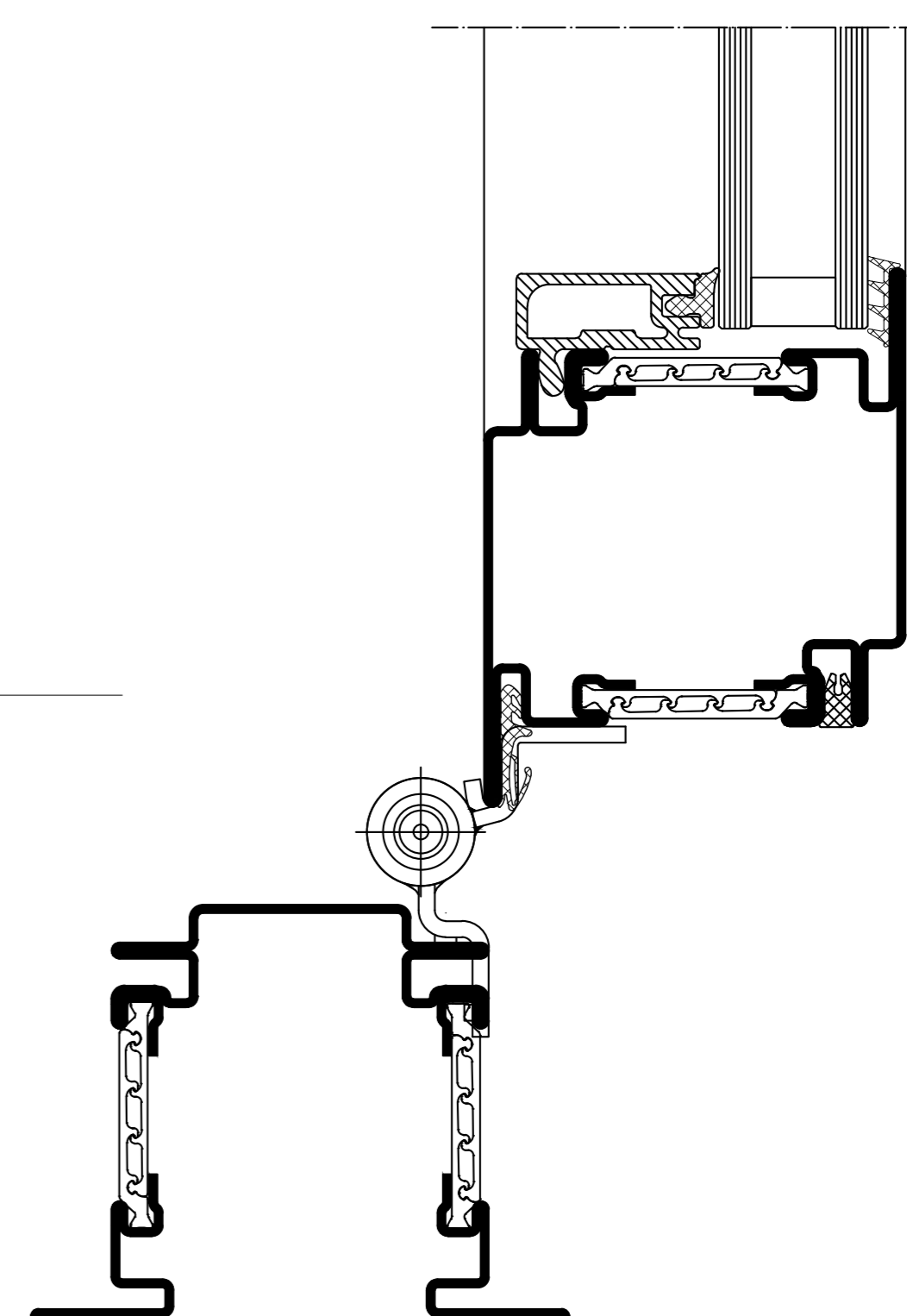

Przekrój pionowy D | vertical section D

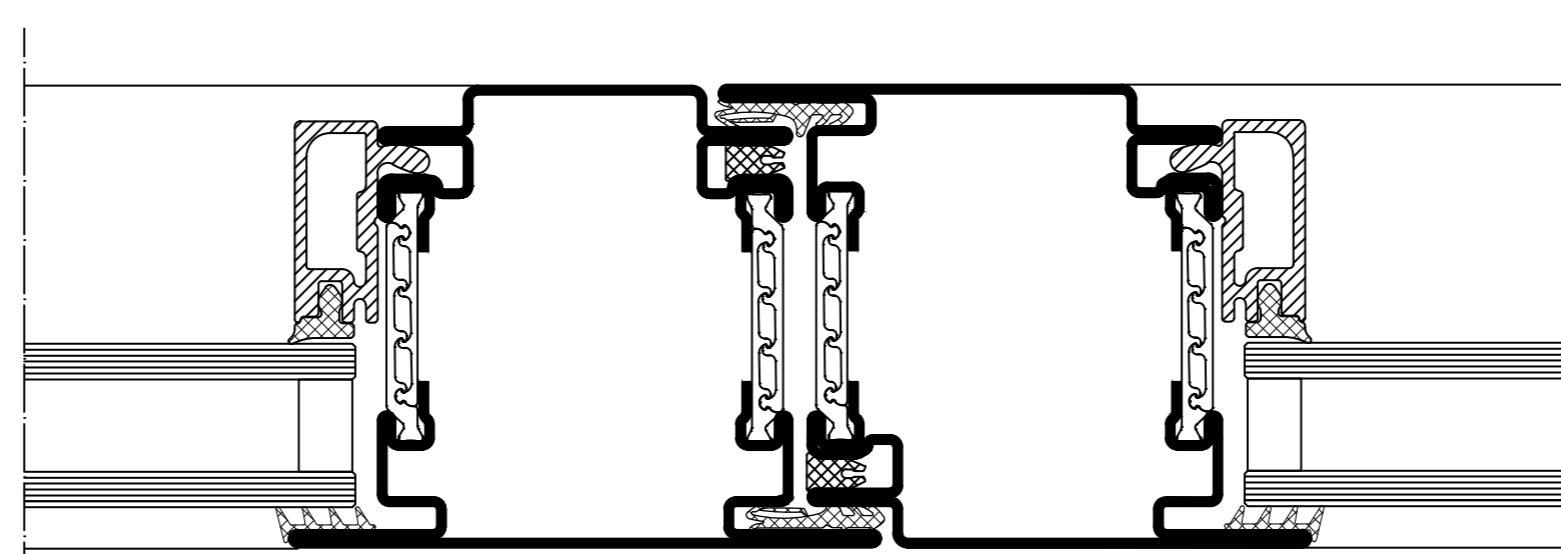

Przekrój pionowy E | vertical section E

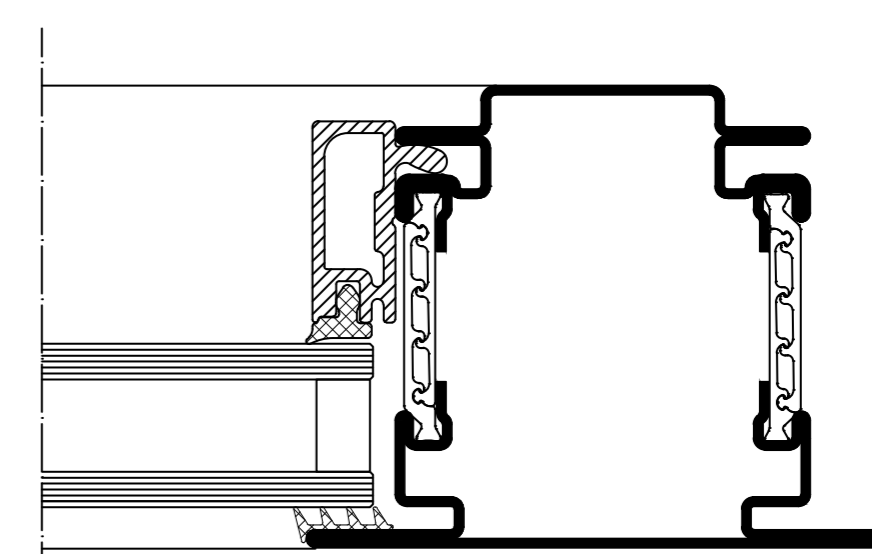

Przekrój pionowy F | vertical section F

